

Crayon Lamp

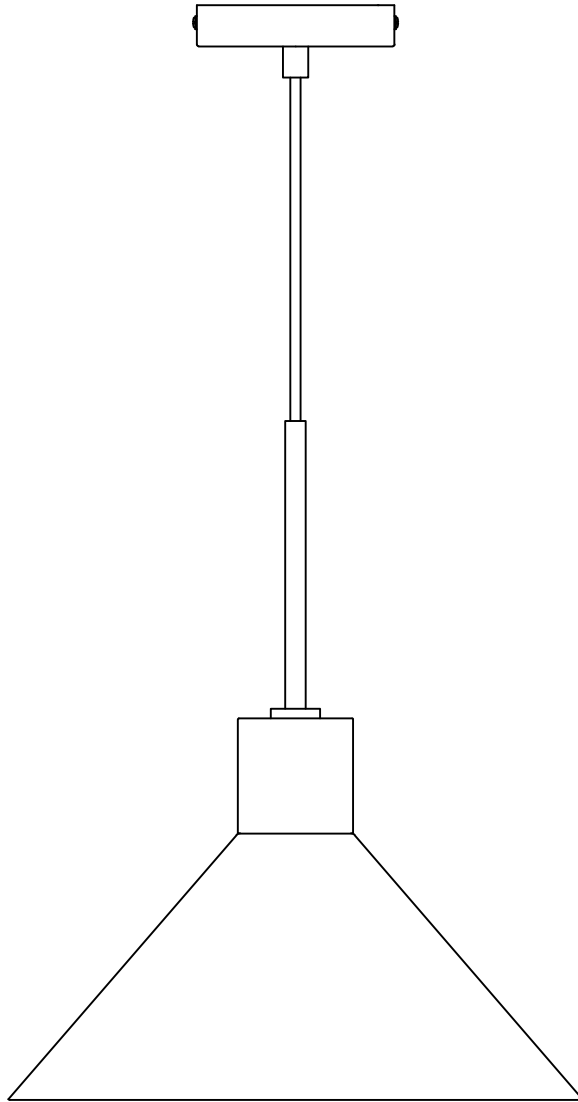

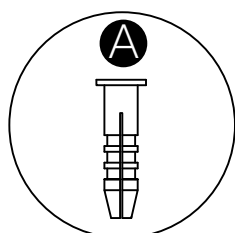

x 2

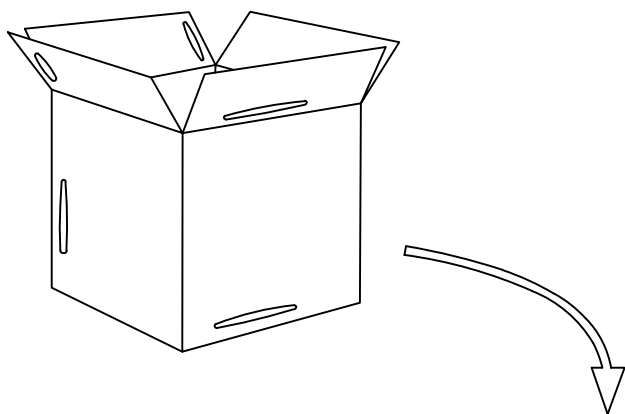
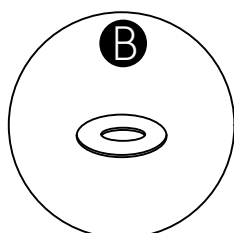

x 2

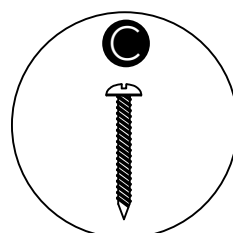

x 2

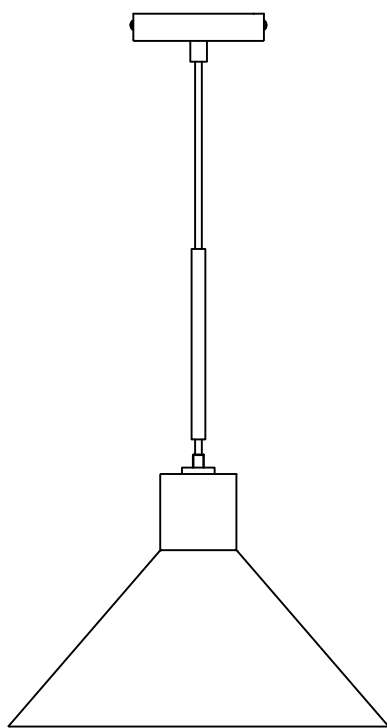

x 1

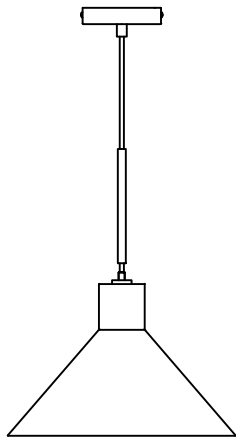

x 1

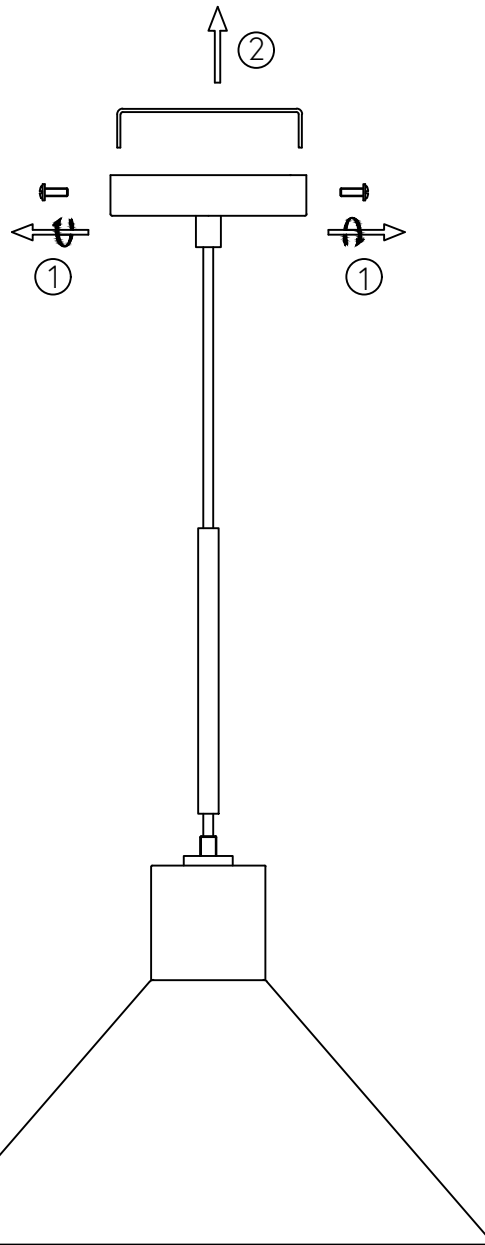

3

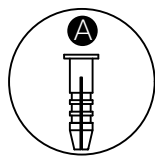

x 2

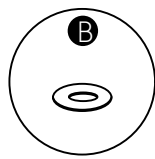

x 2

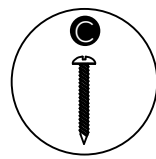

x 2

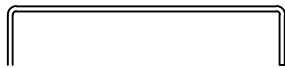

x 1

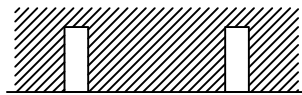

A



B



C



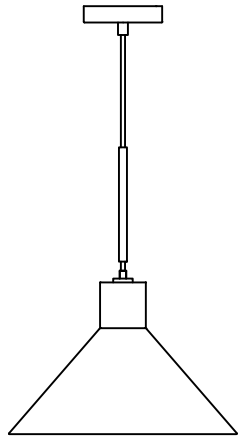

x 1

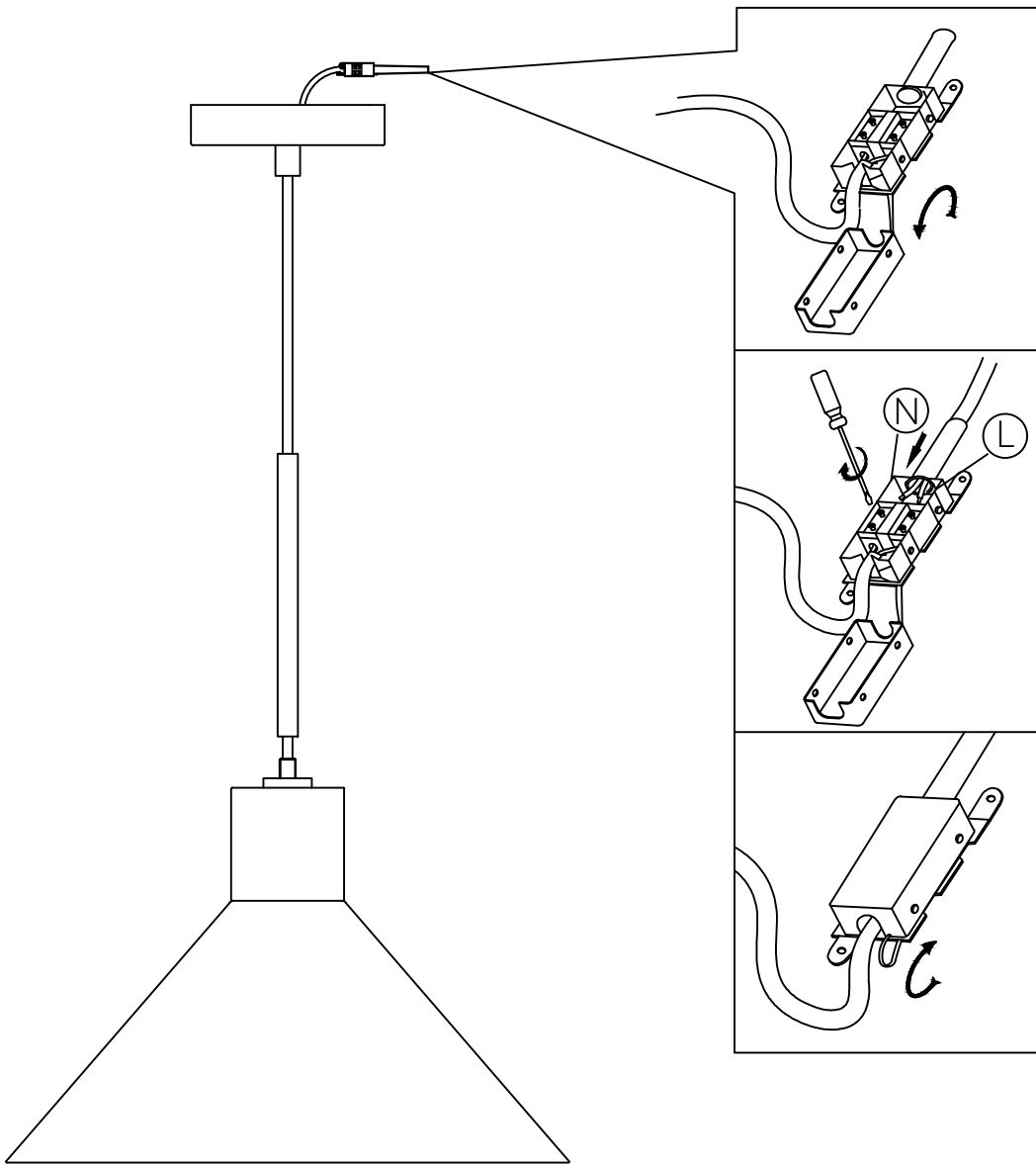

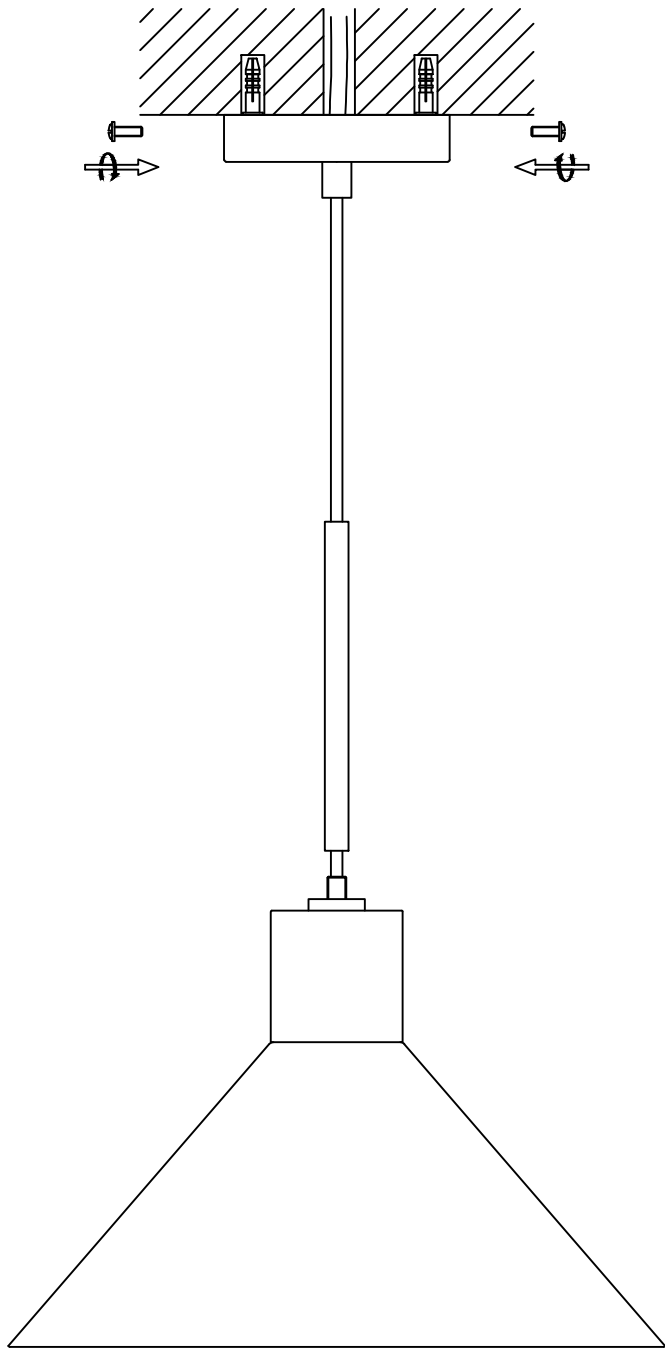

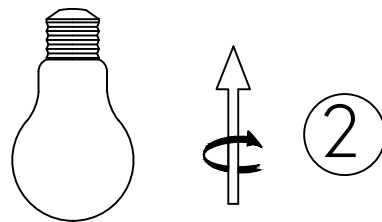
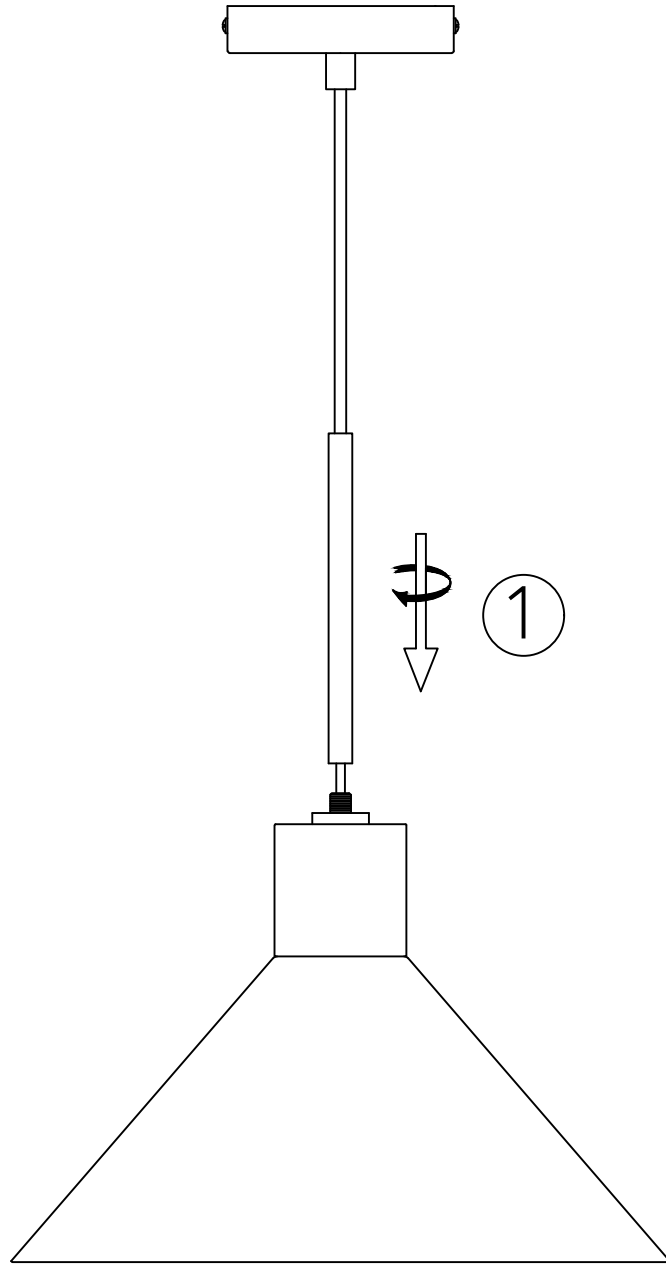

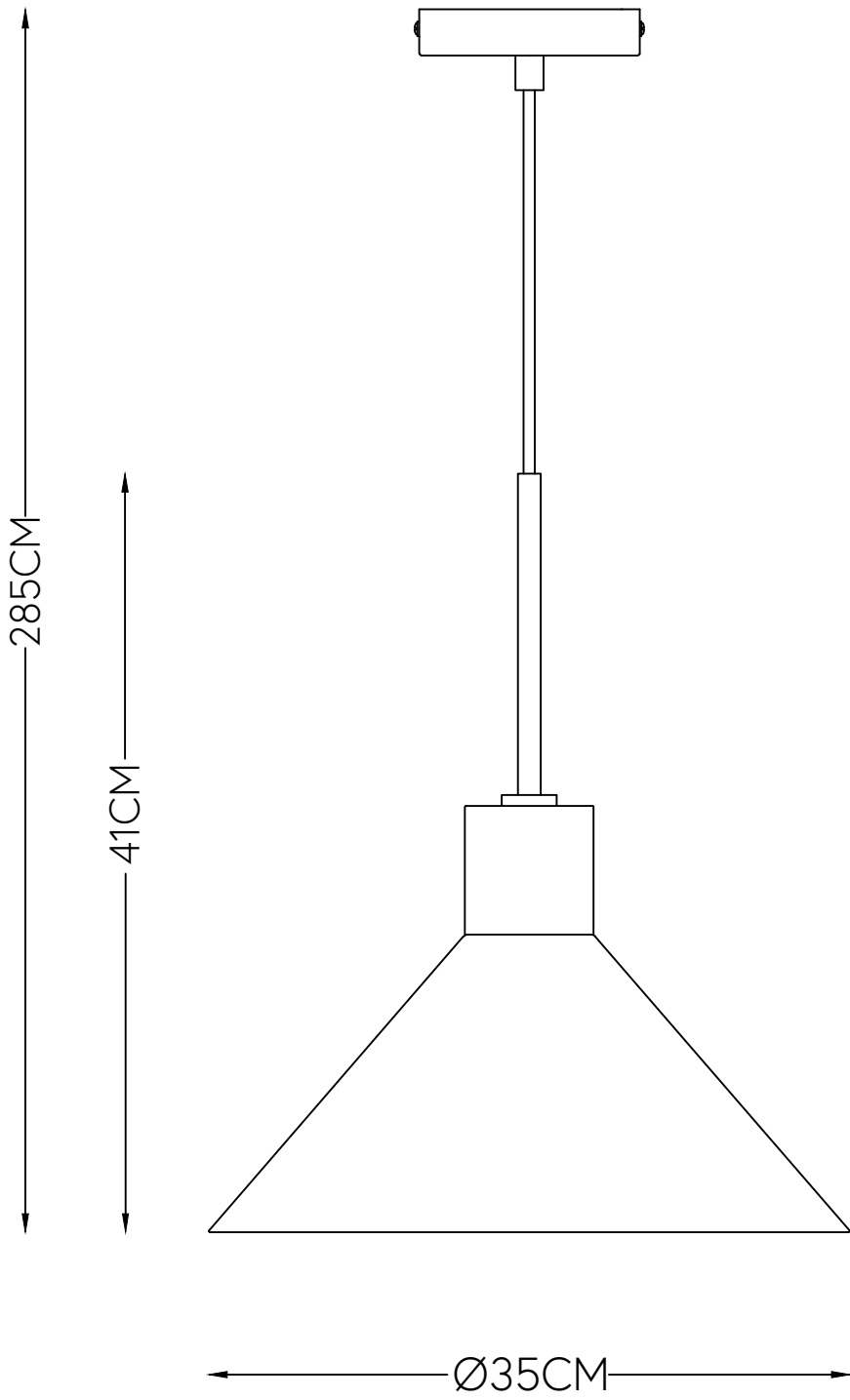

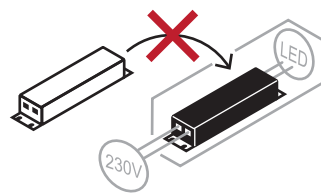
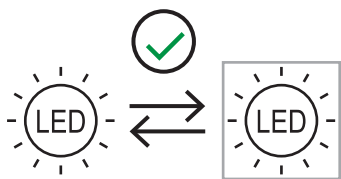

Model number:991406

220-240V~ 50Hz

E27 MAX.15W LED Bulb

Hübsch A/S,Hi-Park 381,DK-7400 Herning

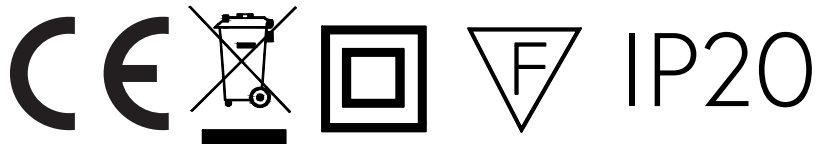

hubsch-interior.com

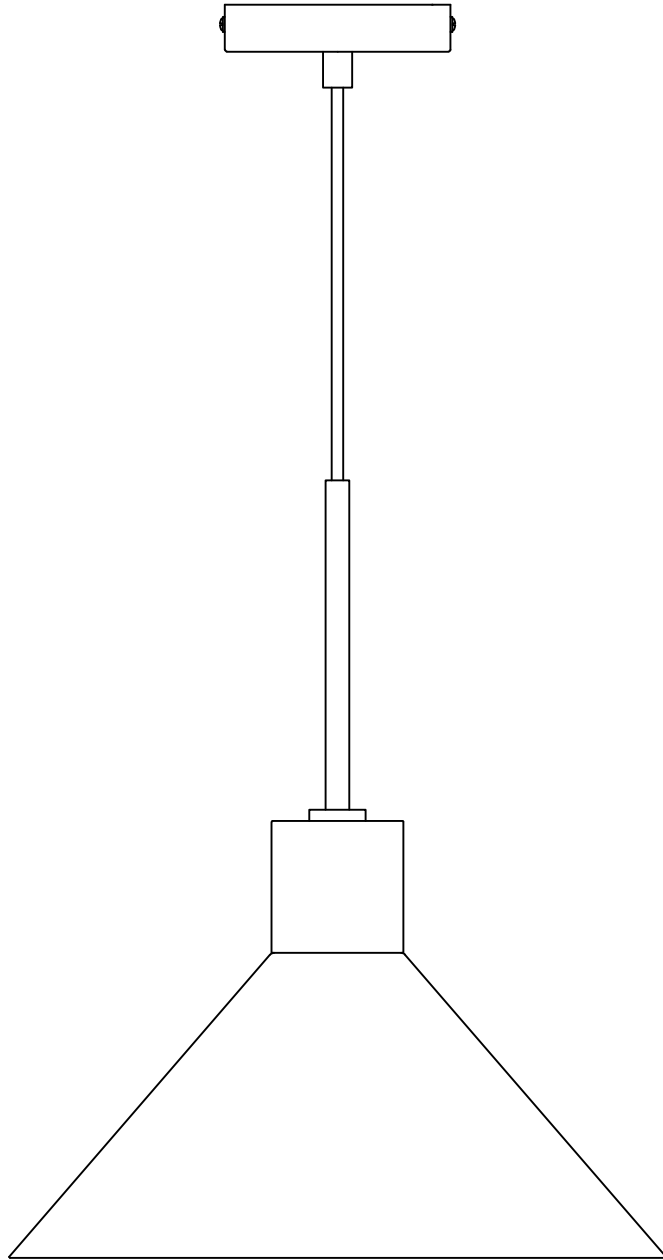

#myhubsch @hubschinterior

Hübsch
DANISH HOME INTERIOR & DESIGN