

# Chipper Table Light

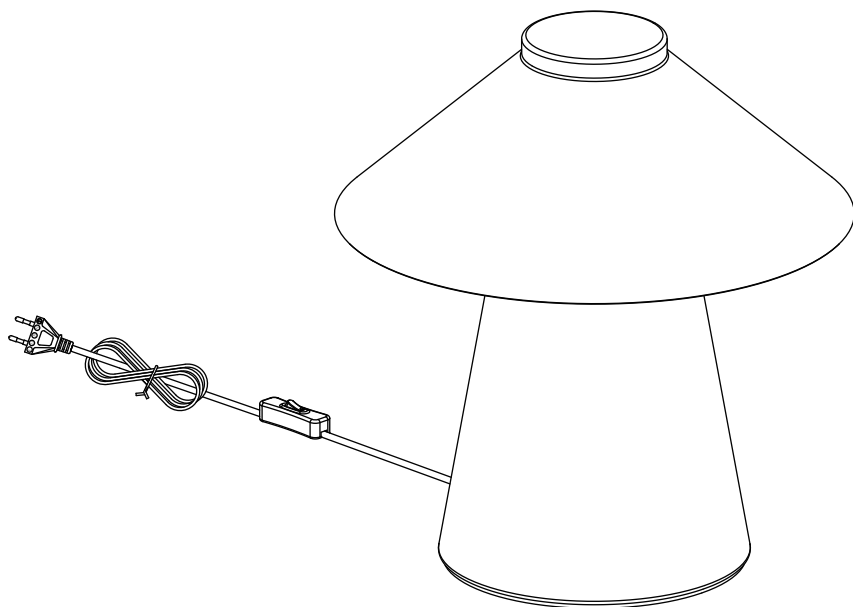

Hübsch

DANISH HOME INTERIOR & DESIGN

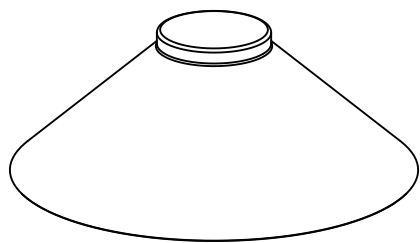
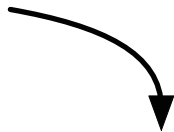
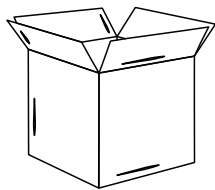

x1

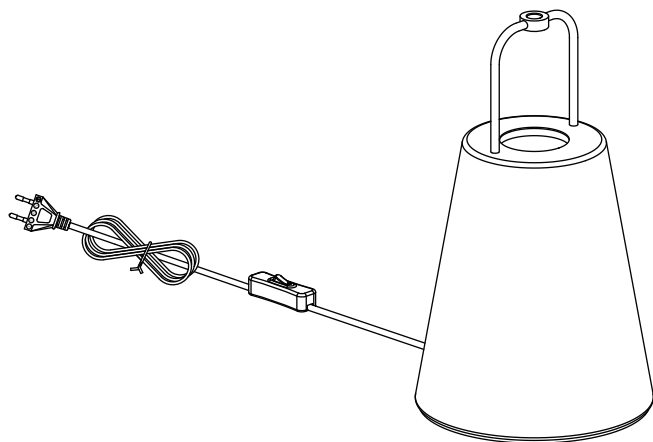

x1

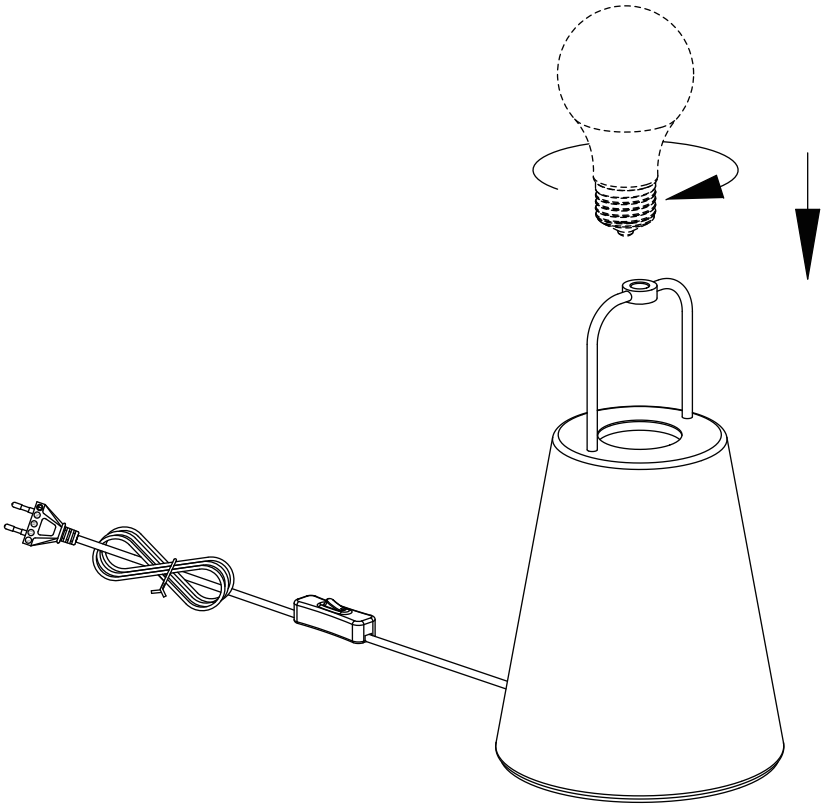

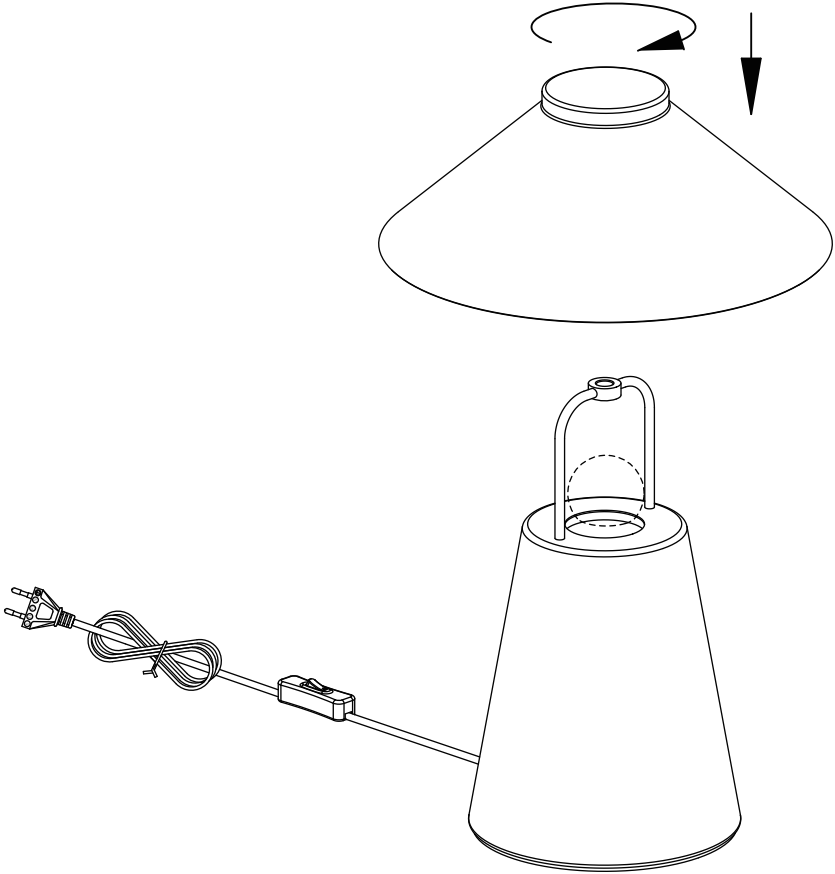

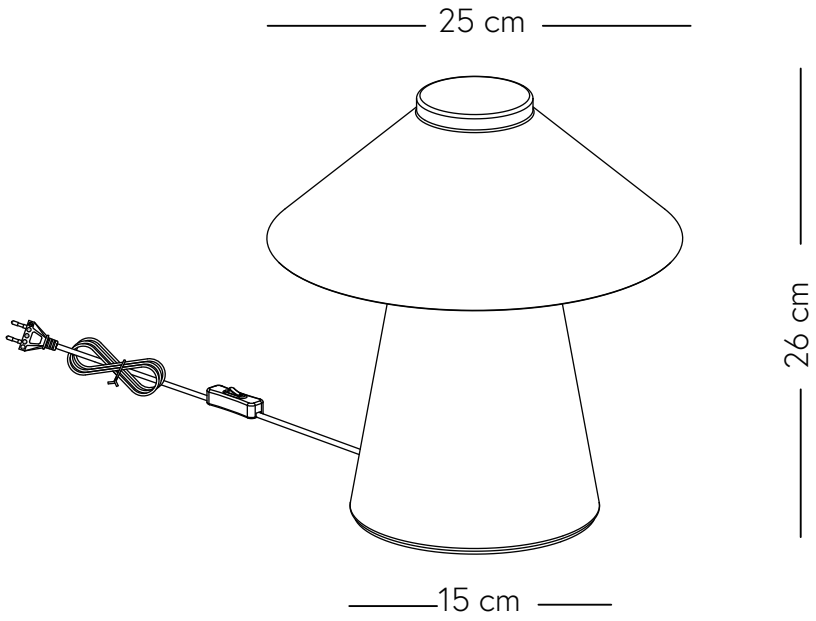



220-240V~50Hz, E27 MAX 60W



[hubsch-interior.com](http://hubsch-interior.com)

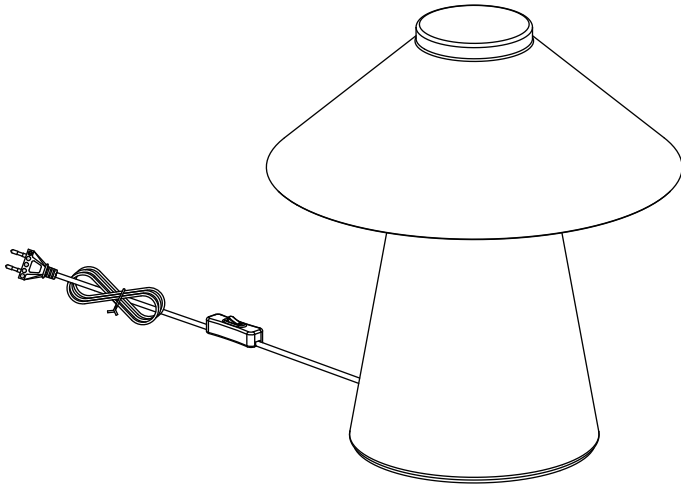

**#myhubsch @hubschinterior**

**Hübsch**  
DANISH HOME INTERIOR & DESIGN