

# Form Table Lamp

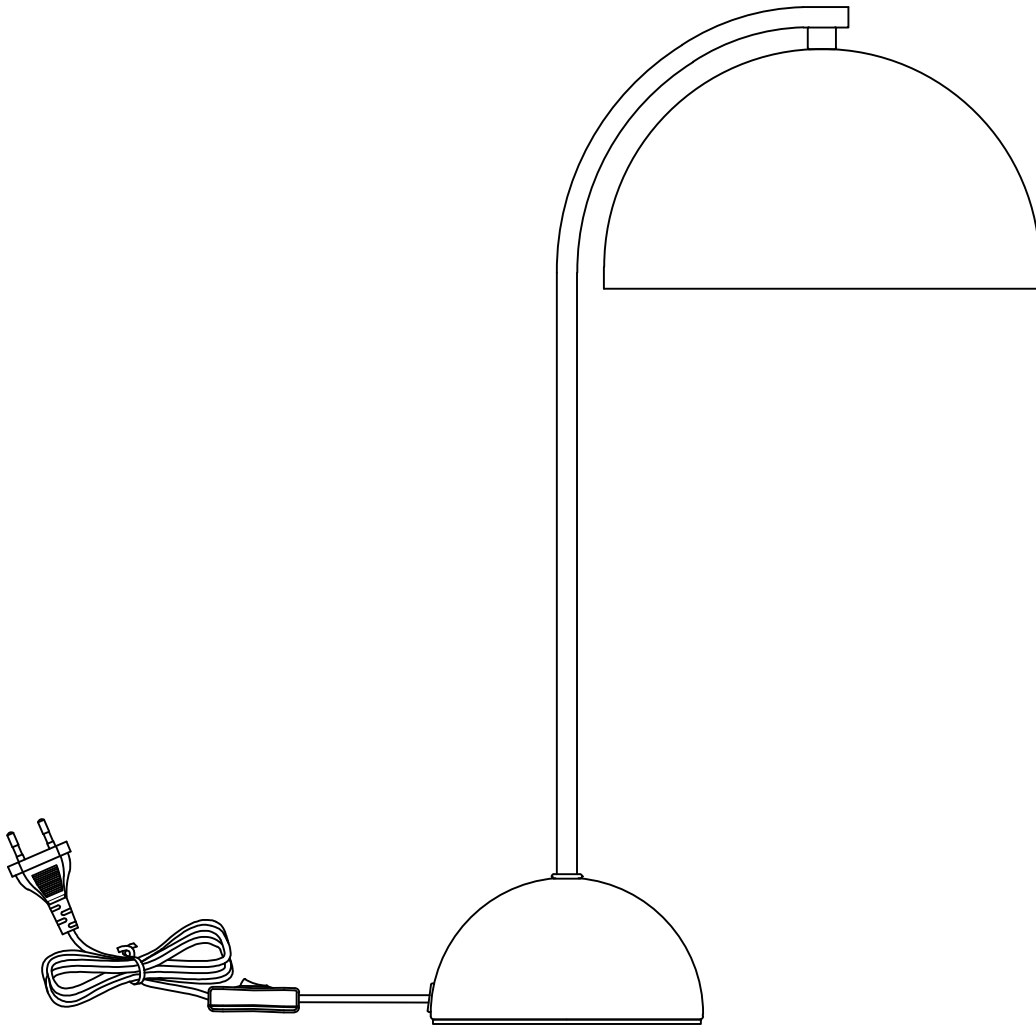

Hübsch  
DANISH HOME INTERIOR & DESIGN

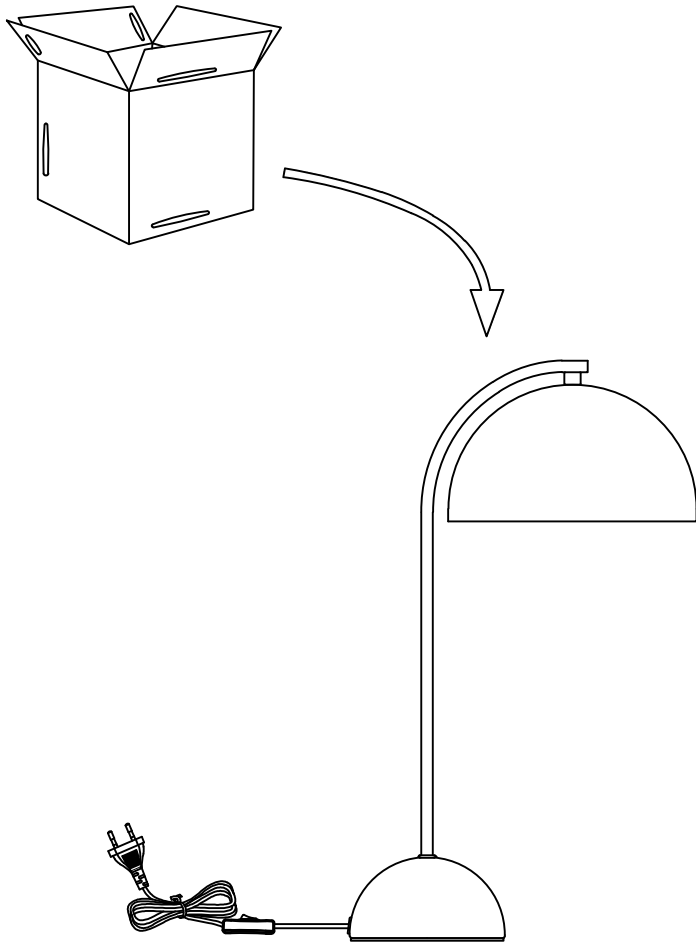

x 1

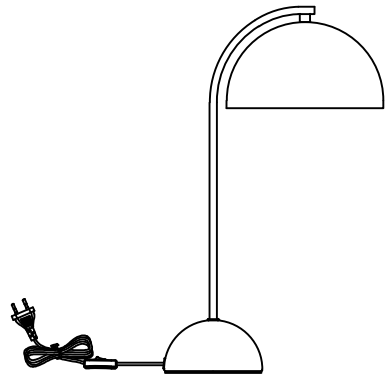

x 1

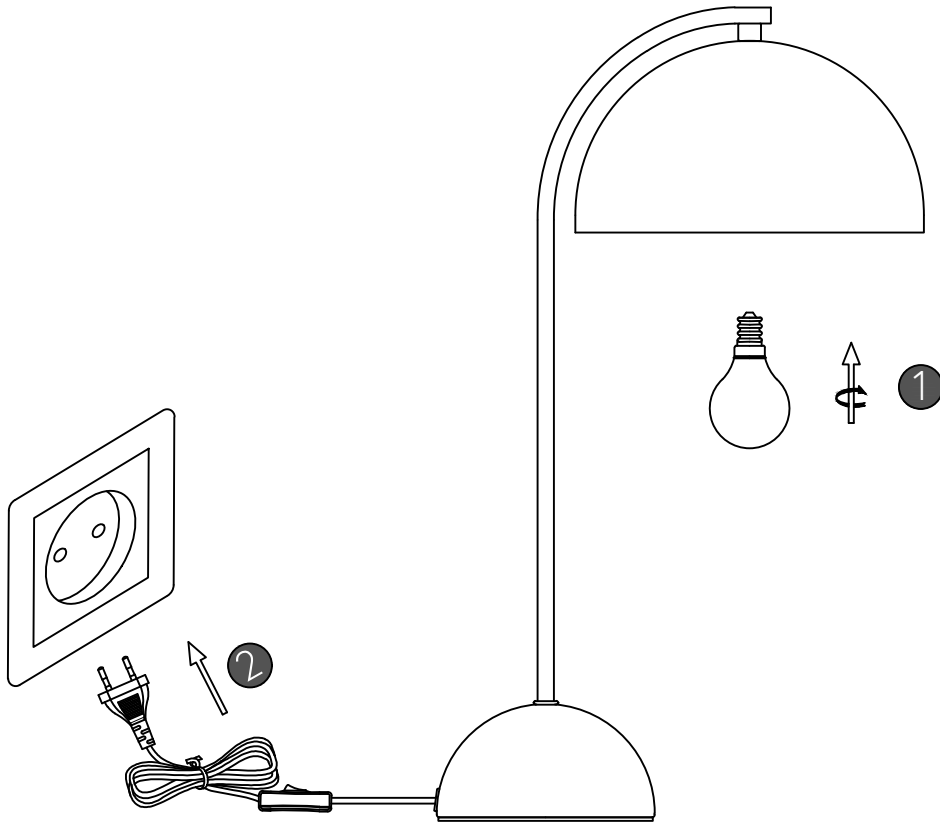



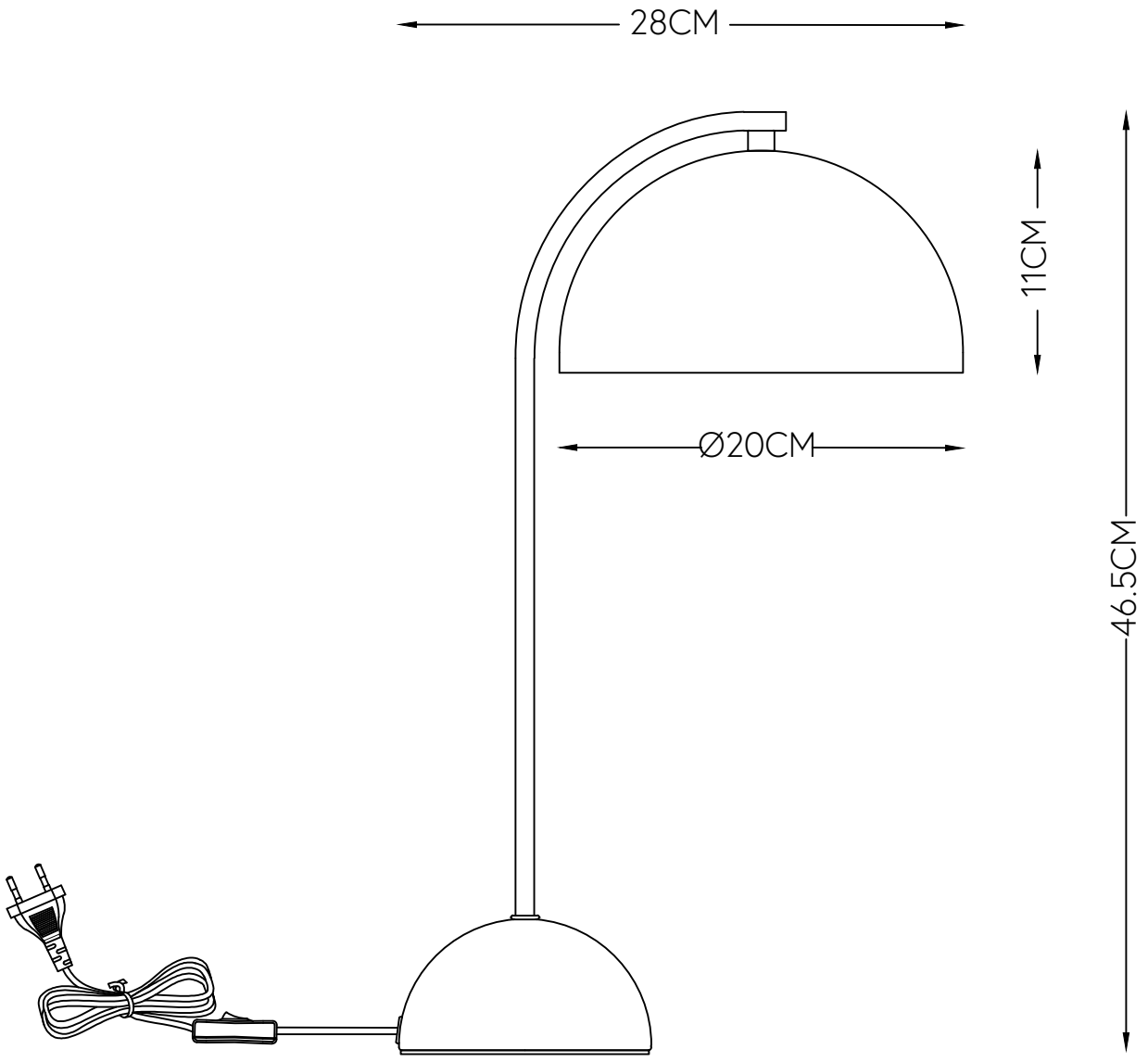



Model number:890602

220-240V~ 50Hz

E14 MAX.15W LED bulb

Hübsch A/S,Hi-Park 381,DK-7400 Herning

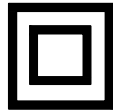

IP20

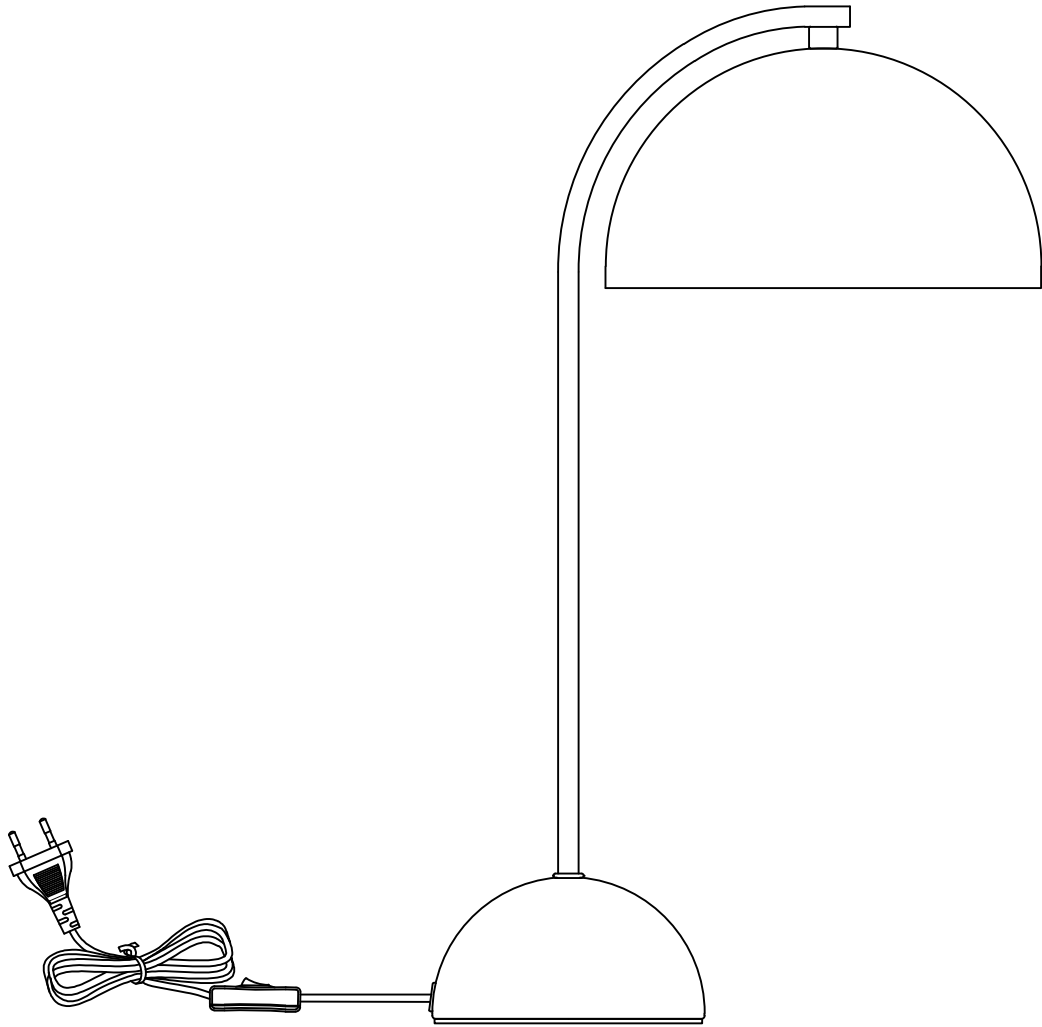

**#myhubsch @hubschinterior**

**Hübsch**  
DANISH HOME INTERIOR & DESIGN