

# Shoji Cabinet Tall

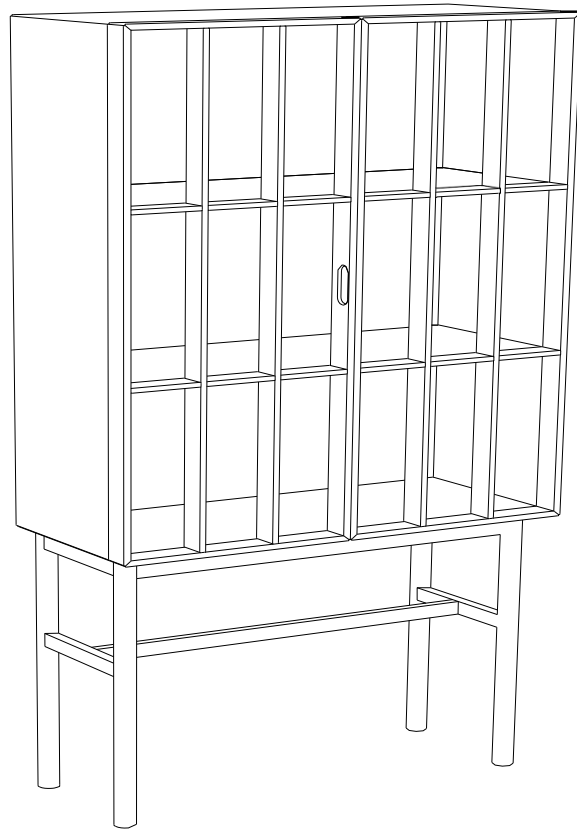

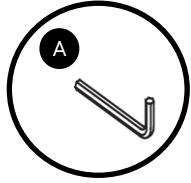

x1

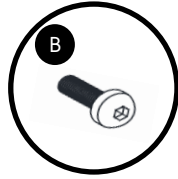

x8

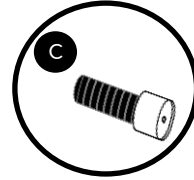

x2

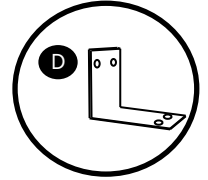

x1

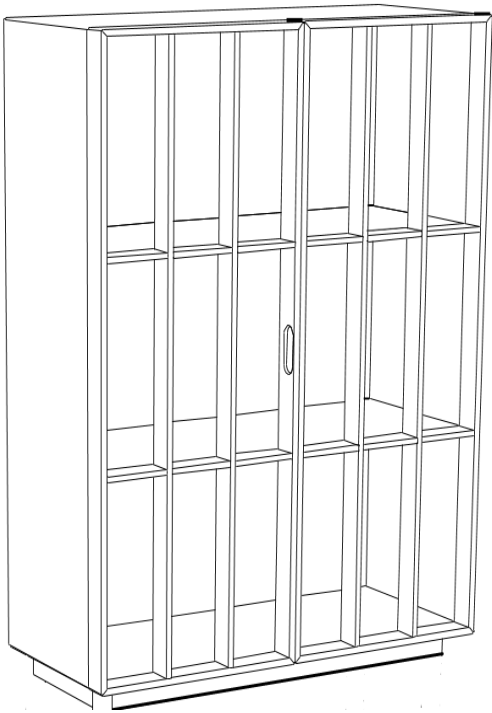

x1

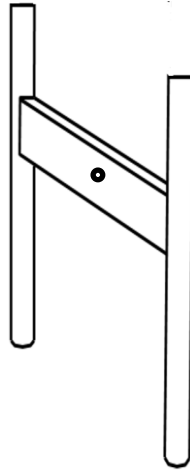

x2

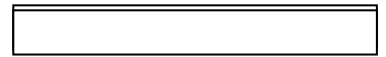

x1

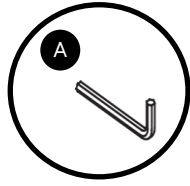

x1

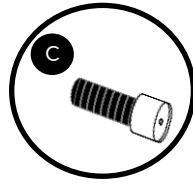

x2

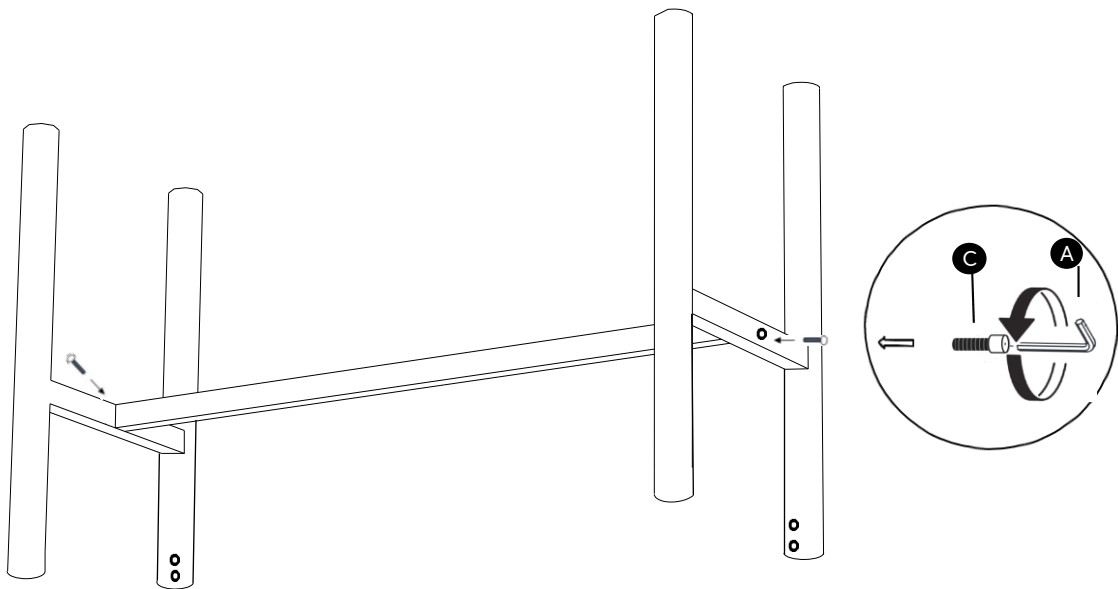

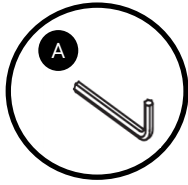

x1

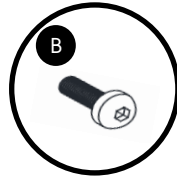

x8

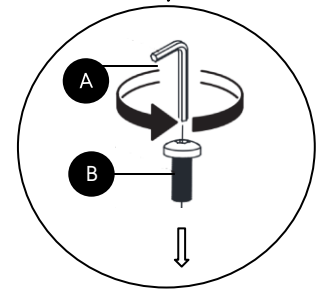
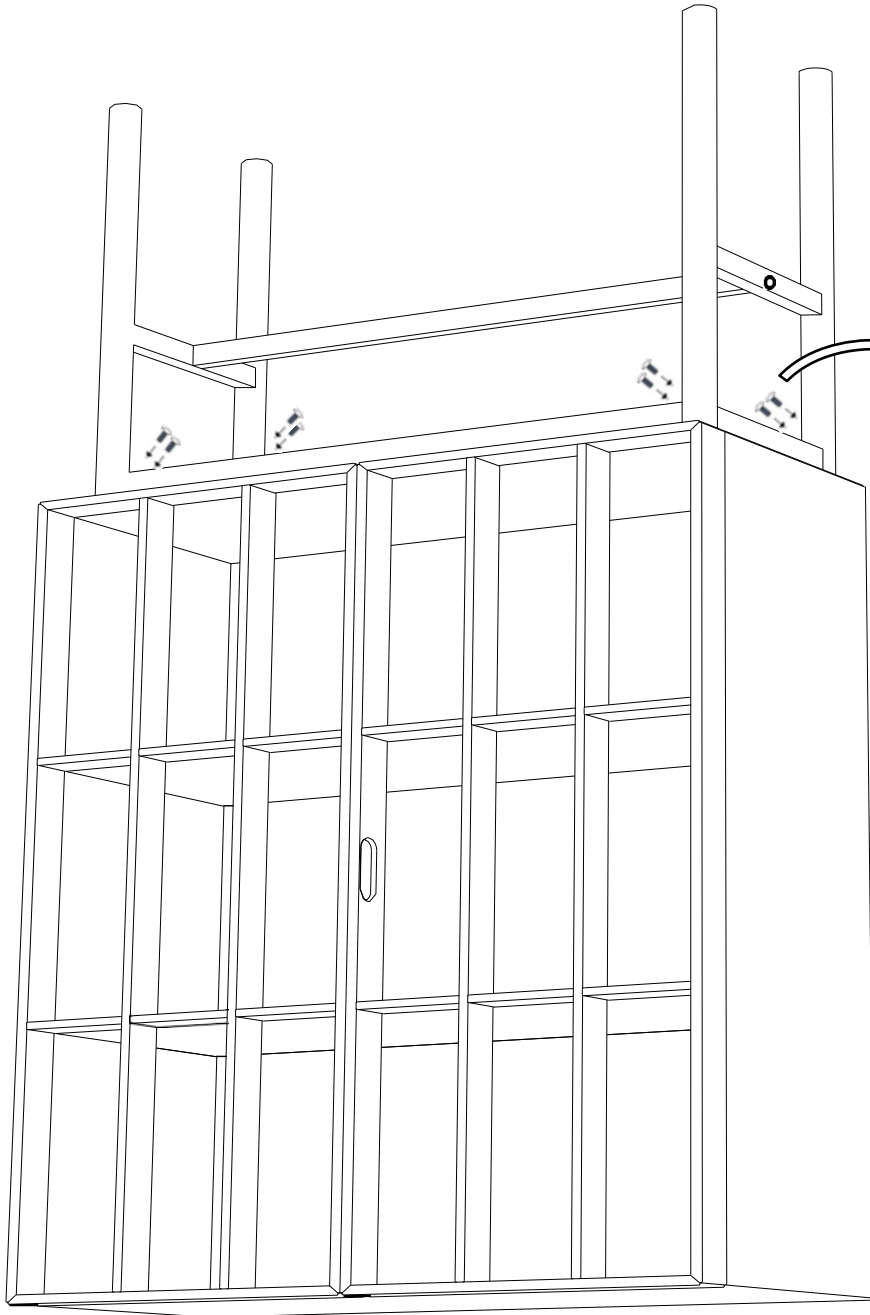

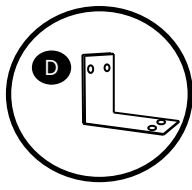

x1

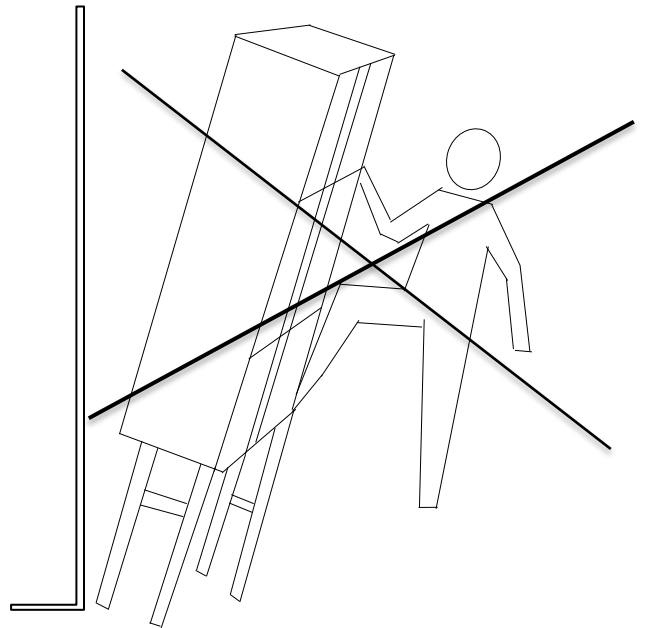
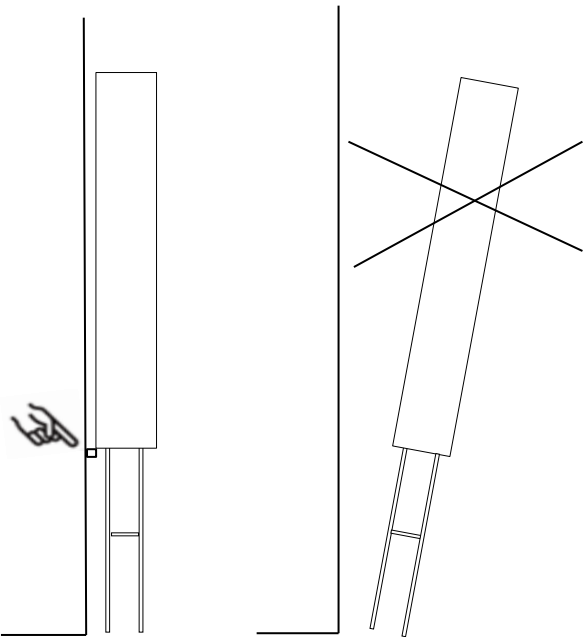
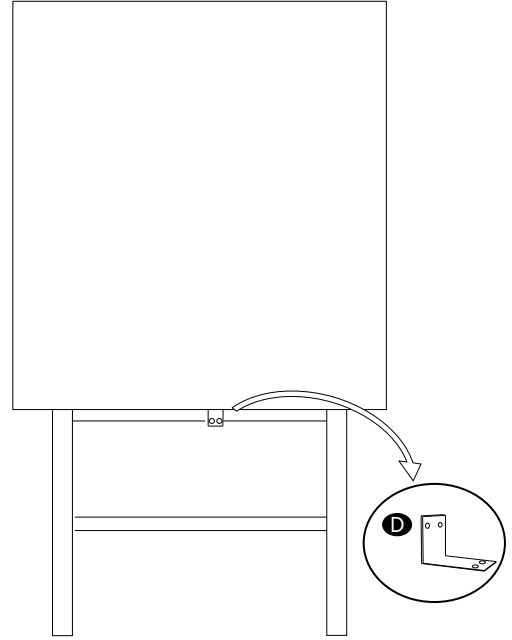
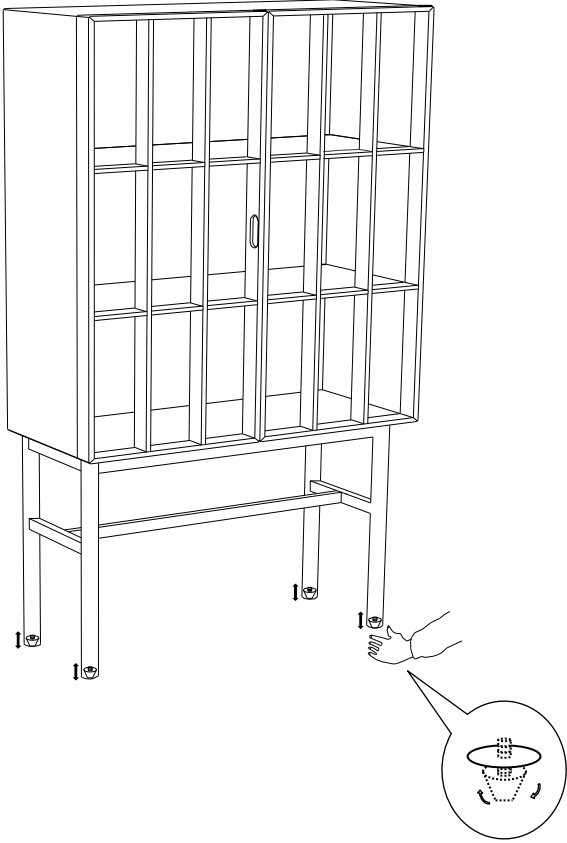

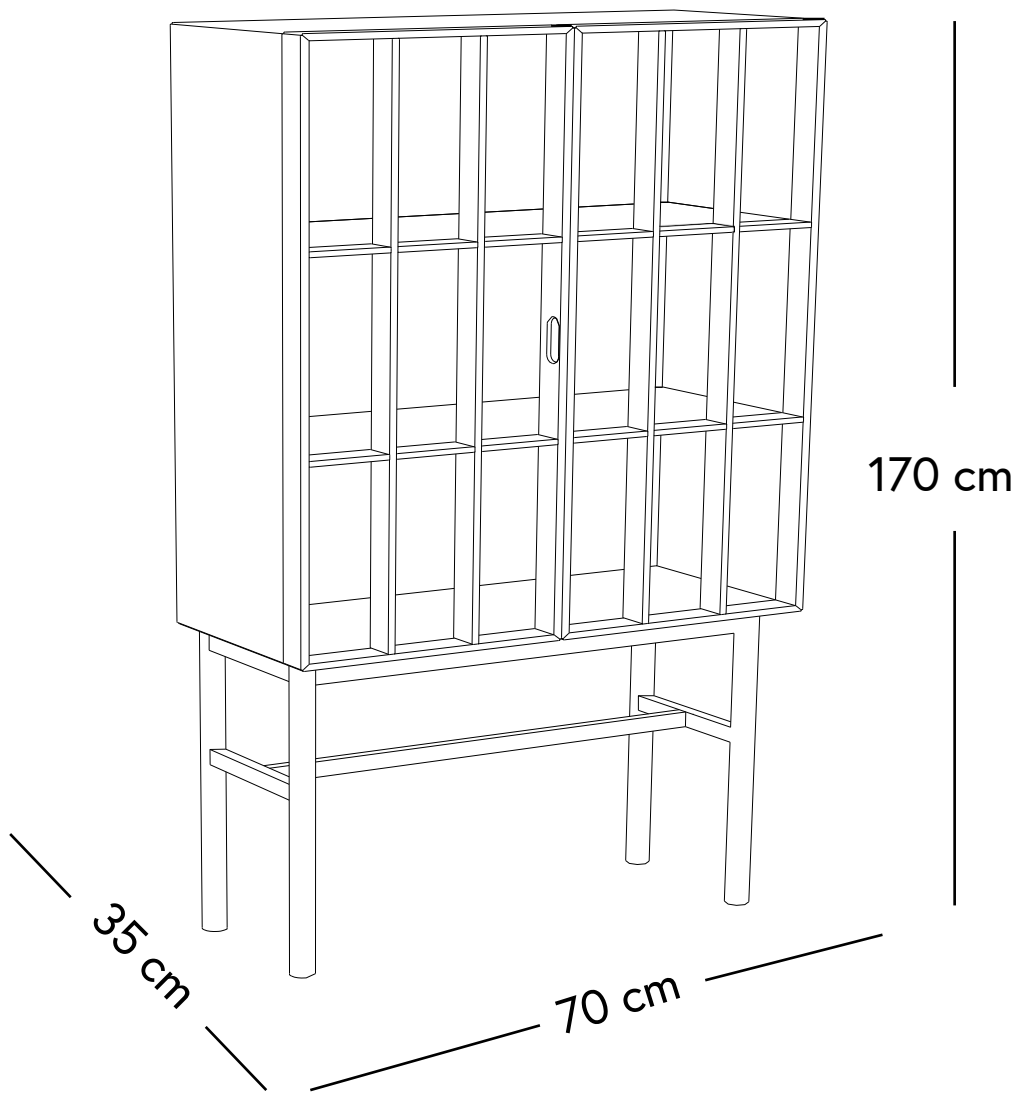



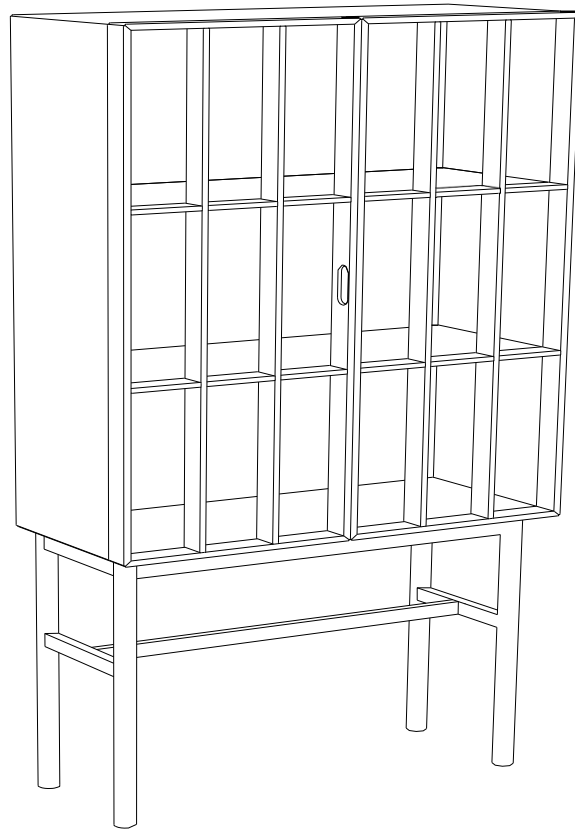

#myhubsch @hubschinterior

Hübsch  
DANISH HOME INTERIOR & DESIGN